

X-Celsior Series

DAY & NIGHT DIGITAL RIFLESCOPES



MANUAL



AMERICAN
TECHNOLOGIES
NETWORK
CORP.

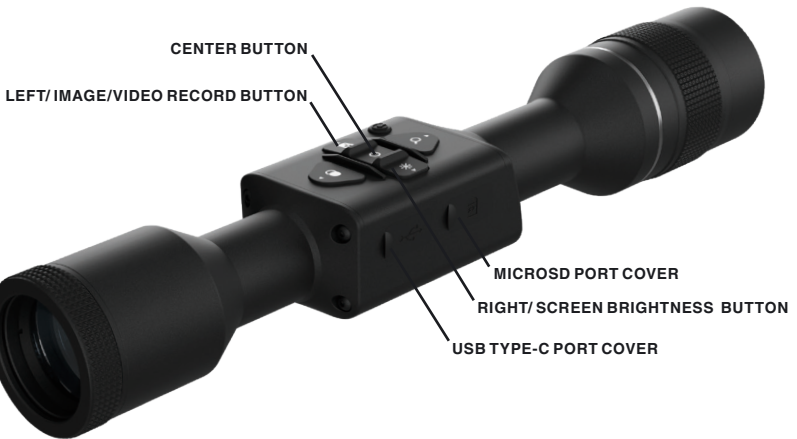
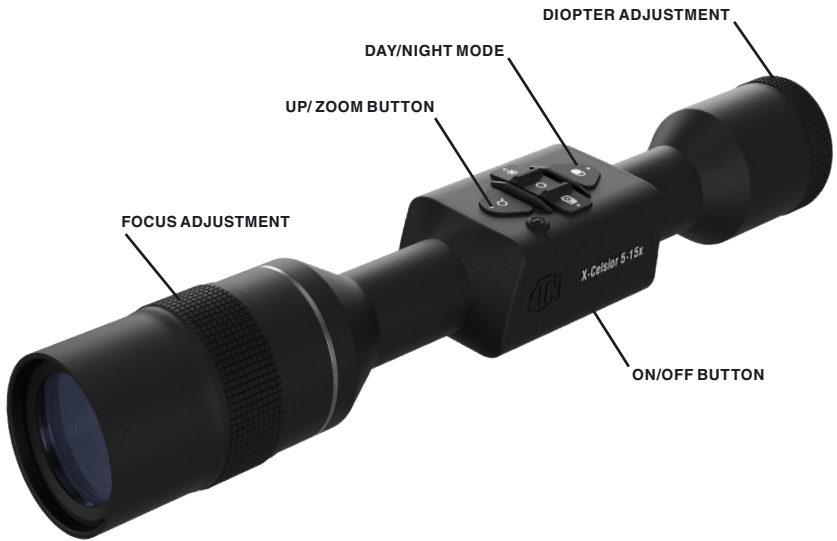

CAUTION!

THIS PRODUCT CONTAINS NATURAL RUBBER LATEX, WHICH MAY CAUSE ALLERGIC REACTIONS

The instructions in this manual are for informational use only and subject to change without notice.

This manual is not to be construed as a commitment by ATN Corp.













ATN Corp. assumes no responsibility or liability for any errors or inaccuracies that may appear in this book.

©2024 ATN Corp. All rights reserved.

TABLE OF CONTENTS

Features	4
Application	4
Specifications	5
Preparing the Device	6
Unpacking	6
Using your Keypad	7
Focusing	7
Mounting Your Scope	7
Interface	8
Main Operations	8
Homescreen	8
Menu	8
Stadiametric rangefinder	9
Zeroing	10
Reticle	10
MIL-DOT reticle	11
Record Video / Image Capture	13
Settings	13
Warnings and cautions	14
3 Year product Warranty	14
Limitation of liability	15
Product warranty registration	15
Obtaining warranty service	15

FEATURES

-  **DAY/NIGHT MODE**
-  **RECORD HD VIDEO**
-  **IMAGE CAPTURE**
-  **ONE SHOT ZERO**
-  **STEP ZOOM**
-  **3D GYROSCOPE**
-  **3D ACCELEROMETER**
-  **MULTIPLE RETICLES**
-  **USB TYPE C**
-  **ULTRA LOW POWER CONSUMPTION**
-  **ERGONOMIC DESIGN**
-  **STADIAMETRIC RANGEFINDER**

APPLICATION

The latest in ATN's HD Optics. The ATN X-Celsior scopes are powered by the new revolutionary ATN X-Celsior Core that is optimized for low power consumption, in a small and ergonomic form factor.

Vivid and crisp clarity during the day. Plus, amazing night time performance, delivered by the new QHD+ sensor.

We are keeping the features in this model to a mandatory minimum while adding several very useful ones, giving the user a simple no frills experience with a price point that's hard to beat. Record HD Videos, get on target fast with our One Shot Zero, hunt all night with a 10+ hour battery life. Mount on any platform with standard 30 mm rings.

ATN X-Celsior — the digital scope for the masses.

SPECIFICATIONS

	X-Celsior 3-9x	X-Celsior 5-15x
Item #	DGWSXC309NV	DGWSXC515NV
Magnification	3-9x	5-15x
Field of View	9° diagonal	6° diagonal
Sensor	2688x1944 pixels Ultra High Sensitivity	
Core	ATN X-Celsior core	
Micro Display	High Definition	
Eye relief	90 mm	
Video and Photo Recording	High Definition	
3D Gyroscope	Yes	
3D Accelerometer	Yes	
Night Vision Mode	Yes	
Reticles	Multiple simple reticles, ATN Predator reticle, MIL-DOT reticle	
Miscro SD Card	4 Gb to 64 Gb	
USB, type C	Charging Port	
Mount	30 mm Standard Rings (included)	
IR Illuminator	Included in the device set	
Battery type	Internal Lithium-ion Battery	
Battery life	≥10 hrs	
Battery charging	Trough the USB Type-C port	
Waterproof rating / IP rating	Weather resistant	
Operating Temperature	-20°F to +120°F / -28°C to 48°C	
Dimensions (body only)	12.2"x2.2"x2.2" 310x55x55 mm	13"x2.2"x2.2" 330x55x55 mm
Weight	1.6 lb / 745 g	1.7 lb / 780 g
Warranty	3 years	

* ATN reserves the right to change the above specifications at any time without notice.

PREPARING THE DEVICE

UNPACKING

The following steps must be performed before using the device:

1. Open packaging box, remove X-Celsior and check the contents.
 - X-Celsior
 - Lens cap
 - Eyecup
 - Scope pouch
 - 2 x standard mounting ring and 1x L-shaped ring
 - USB Type C cable
 - IR Illuminator
 - IR illuminator battery
 - Battery charger
 - IR illuminator mount to Picatinny
 - User manual
 - Lens cleaning cloth
 - Warranty card
2. Make sure that nothing is missing.
3. Inspect the device for damage to optical surfaces, body, eyecups, operation buttons, etc.
4. Ensure that all optical surfaces are clean and ready for use.

NOTE

If any accessories are missing or broken contact ATN's Customer Service at 1.800.910.2862.

CHARGING THE DEVICE

The device is equipped with a USB Type C port for charging. You will find it under the rubber cap on the right side of the device.

We have included a USB Type C charging cable with your scope. Plug the cable into a USB wall charger that has an output of 2 amps (Wall Charger not included).

Charge your scope for 6 hrs using a 2 A USB wall charger.

Note

Using a wall charger with lower amperage will take longer to charge your scope.

1. Recommended charger is 2 A USB charger.
2. Battery charging time (from 0 to 100%) is 6 hours with 2 A USB charger.
3. Battery run time is 10 hours on a single charge.



ON/OFF

To Turn On the device press and hold power button until you hear a click (3-5 seconds) then ATN logo will appear on the screen.

To Turn Off the device press and hold the Power button.

If the scope freezes or stops responding to the control panel, press and hold the Power button for 3-5 seconds wait 5-10 seconds and to Turn On the device.

USING YOUR KEYPAD

The keypad is programmed to be used in two different ways:

- Short and Quick Taps — used for most functions and to navigate the menu.
- Press and Hold — designed to be used in the following situations — On/Off, Video recording, Stadiametric rangefinder.



FOCUSING

DIOPTRER ADJUSTMENT

By rotating the Diopter Adjustment Ring you will achieve optimal sharpness for your vision. Look through the eyepiece, focusing on the reticle and widgets on the screen. Rotate the diopter adjustment until the reticle and widgets are perfectly sharp in appearance.



NOTE

Once the Diopter Adjustment is set to your liking, adjustment will not need to be performed unless another user altered the focus for their needs.

DISTANCE FOCUS

Rotate the Adjustment Ring, as necessary, to achieve the proper focus at various distances.

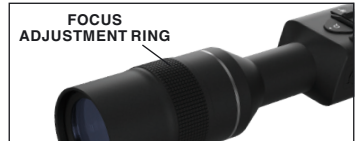

MOUNTING YOUR SCOPE

CAUTION!

Make sure your weapon is not loaded. Use safe weapon handling procedures at all times.

The X-Celsior has a 3.5-inch eye relief, and can be mounted using 30 mm mounting rings. Place the scope on the bottom half of the rings you just mounted to the weapon's rail, verifying you have sufficient eye relief for your platform. Place the top portion of your ring over the mounted bottom portion, make sure the holes align and the screws turn easily. Apply equal torque to all screws. Make sure your rings are tight on your rifles rail and will not come loose due to recoil.

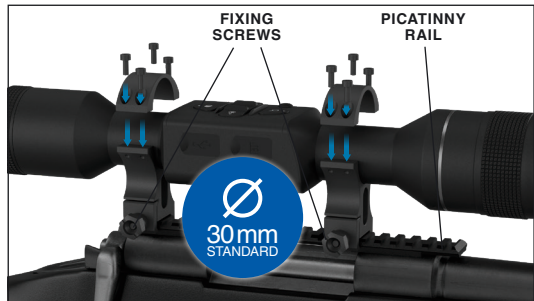

INTERFACE

MAIN OPERATIONS

OPERATION WITH KEYPAD

1. On/Off button. A long press of this button (3–5 seconds) will either power on the unit or power off the unit, depending on the current status of the scope.

2. Up button. A short press of this button will cycle you through your change in zoom (3-5.4-7.2-9x or 5-9-12-15x).

3. Left button. A long press will start/stop Video recording. A short press on the left button to take a picture. It is also used to go back from Sub menu to Main menu.

4. Center button/OK. Pressing the Center Button will open the Menu. Also is used to make a selection in the Menu.

5. Right button. A short press will allow you to change the display brightness (1 → 2 → 3 → 1).

6. Down button. A short press will cycle from Day mode to Night mode. Press and Hold will take you to Stadiametric rangefinder.

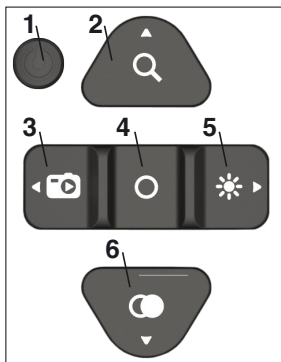

HOMESCREEN

The first screen you'll see after turning on the device is the Homescreen. It consists of Scales, Status Bar icons and different Information Widgets.

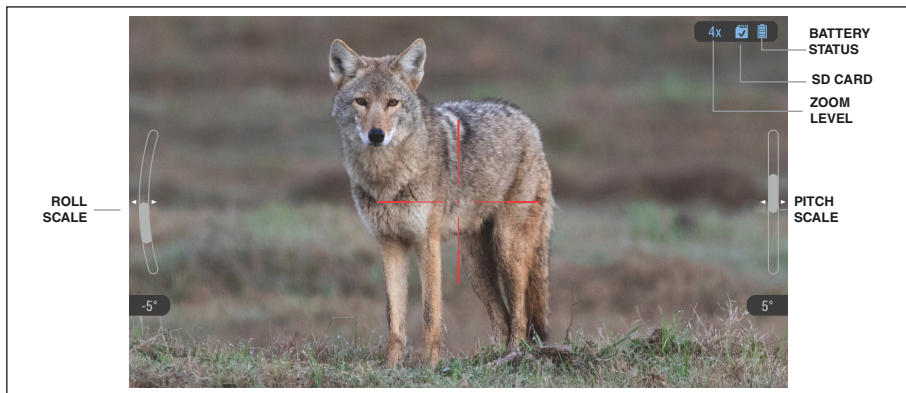

SCALES

- Roll Scale shows the rifles cant based on internal 3D Gyroscope.
- Pitch Scale shows rifle inclination based on internal 3D Gyroscope.

MENU

To open the Menu, perform a short press of the Center button. You will see the Menu appear on the left of the screen with the following Icons:

STADIAMETRIC RANGEFINDER. This feature allows you to measure the distance to the object, based on the object size.

ZEROING. This option gives you access to the One Shot Zero, in order to Zero your reticle to your weapon.

RETICLE. This option allows you to select one of eight reticles available in the scope. Also, you can change the reticle color in this menu.

SETTINGS. In this menu you will find various settings that you can adjust in your scope:

- Format SD card
- Sleep Mode
- R.F units
- N. M. Sensitivity
- Display Widgets
- Restore factory settings
- Zeroing units
- Date and Time
- Language
- Exit

EXIT. This option allows you to exit to the Main screen.

STADIAMETRIC RANGEFINDER

To open this feature, you have two possibilities:

Shortcut

Press and Hold button Down to activate stadiametric rangefinder from the Main screen.

From the Menu

Press Center button to open the Menu.

Find S.Rangefinder icon and press Center button to select it.

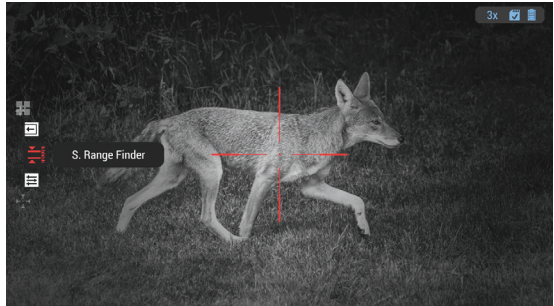

To measure the distance to your target use buttons Up and Down to adjust the lines and to fit the object between the lines, then the distance will automatically be displayed below the object icon.

For correct distance measurements the lines need to be placed on as follow:

- Rabbit - Upper line needs to be placed on the top of the head (without ears) and bottom line needs to be placed below the legs.
- Coyote/Jackal - Upper line needs to be placed on the top of the back and bottom line needs to be placed below the legs.
- Wild boar - Upper line needs to be placed on the top of the back and bottom line needs to be placed below the legs.
- Custom - Allows the user to set the height of the known object and to measure the distance to it. By pressing the buttons Left and Right you can set the height of the object. The adjustment step is 0.1 meter/yard and is displayed on the left of the icon. Use button Up and Down to place the lines on the top and the bottom of the object and the distance will appear below the Custom icon.

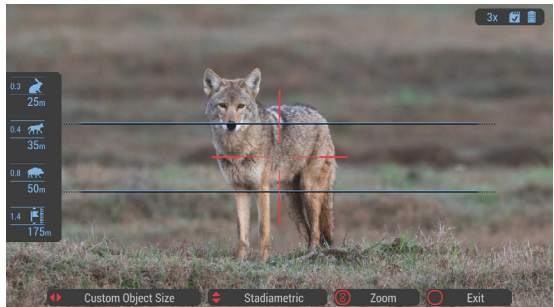

NOTE

Dimensions for Rabbit, Coyote and Wild boar, displayed on the left side of the icons are fixed and cannot be changed.

To close the Stadiametric rangefinder press the Center button.

ZEROING

To Zero your scope you will need to go to the Zeroing section of the Menu. Press the Center button to enter the Menu and then use the Up or Down button to navigate to the Zeroing option in the menu.

Press the Center button to enter zero mode.



You will see on your display two reticles. One will move via use of your keypad, the other will remain stationary. While keeping the gun as steady as possible, fire a round. Using the key pad, move the red reticle to the point of impact while keeping the white reticle on the original point of aim at which you fired the shot. Once you have placed the center of the red reticle on the POI,

short press the Center button to save the zero. If you feel confident that you have the best possible zero, use the Left button to navigate to the exit symbol to the left. Short press the Center button to exit the menu and return to the Home-screen. If you need to fine tune the zero you can refer to the previous instructions to fine tune the zero. During the zeroing process the reticle coordinates are displayed in the upper left corner in the form of X | Y. At base magnification, the reticle coordinates move by one pixel per click.

NOTE

Although you may not need more than one shot to Zero your scope, we do recommend that you fire additional shots once the initial zero process is complete to insure the optic and weapon are truly Zeroed. If additional corrections need to be made to fine tune the zero, then make those corrections as needed.

RETICLE

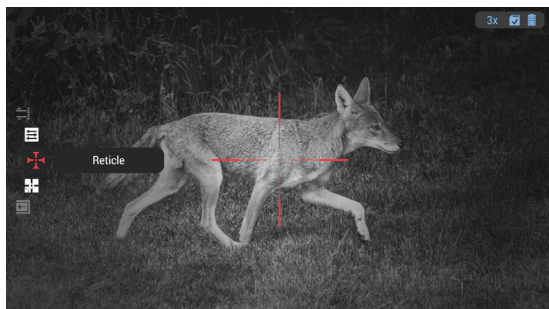

Reticle Style

Once in the Menu screen, use the Up or Down button to navigate the Reticle menu. Short press the Center button to go to Reticle options. Use the Left or Right button to cycle through the Reticle options. Once you find the Reticle you intend to use, short press the Center button to confirm your selection. You have a selection of 8 different reticles.

Reticle Color

In order to change the Color of the reticle. Short press the Center button while the Reticle menu is selected. Use the Up or Down button to cycle through the Color options. Once you reach the Color you like short press the Center button to confirm the selection.



MIL-DOT RETICLE

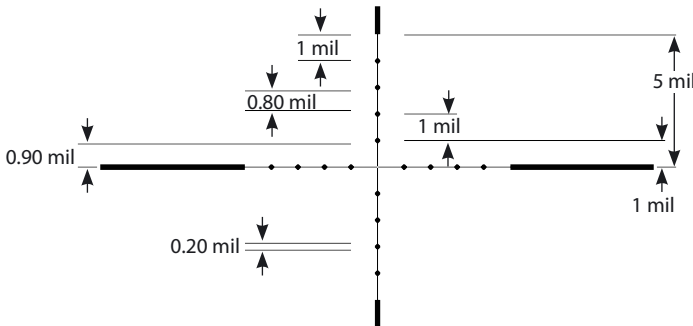

The MIL-DOT reticle has the standard dimensions of a classical MIL-DOT.

At base magnification, it can be used to quickly aim with the center at low magnifications.

At high magnification it can be used to measure object sizes at known distances or range to an object of known size.

It can be used to compensate for bullet drop and for windage at different distances within the reticle range of +/- 5 mil.

ATN Predator reticle

The ATN Predator reticle is specially designed for predator hunting. It is designed to match the ballistic profile and drop for most of the 55 gr. bullets in .223 Remington and 165 gr. bullets in .308 Winchester

It can be used to quickly aim with the center chevron at 100 yards and to shoot at ranges up to 500 yards with ballistic compensation through 100 yards. The reticle also accommodates wind compensation for 5 mph side wind.

The central crosses of the reticle are used for rangefinding and represent the angular dimension corresponding to 10 inches at the distance for the compensation.

Here an explanation of the reticle and its components:

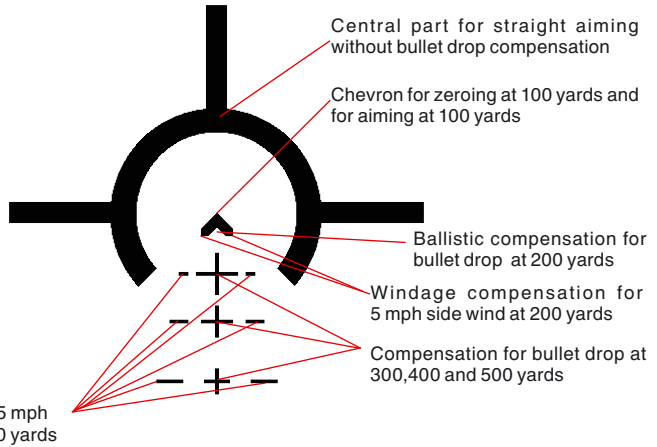

The range finding capabilities of the reticle are designed for coyote hunting and the size of the elements correspond to coyote body height at the chest area. Here is an explanation of the stadiametric rangefinding capabilities of the reticle:

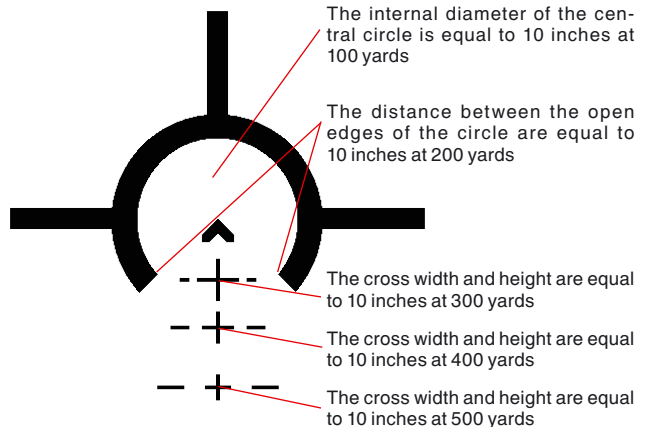

Example:



The coyote chest has about 10 inch vertical size and it approximately fits the cross that corresponds to 300 yards. That means that in order to compensate for the drop, the shooter needs to aim with the same cross that fits the size of the coyote chest - namely the center of the first cross from the top to the bottom.

RECORD VIDEO / IMAGE CAPTURE

NOTE

You should first format the micro SD card in your scope before Zeroing or Recording initially.

The X-Celsior records in stunning HD quality all your latest adventures no matter the time of day or night. Giving you a simple yet powerful scope that records hours of video on to a removable micro SD card. Make sure you obtain a micro SD card that is 4 to 64Gb that is a class 10 SDHC type card.

In order to activate Video recording, long press the Left button to start recording. A long press again on the Left button will stop recording.

You can take HD quality images by short pressing the Left arrow button.

In order to activate image capture, press and hold the Left button to toggle the function from Video Recording to Image Capture. Once you switch from Video Recording to Image Capture, you can take HD quality images by short pressing the Left arrow button. In order to use Video Capture mode once again. You would Press and Hold the Left button once again to toggle the setting to Video Record. When you toggle from Video to Image capture, you will see the Icon change on the Homescreen. Giving you an indication of which mode you are currently using.

NOTE

When you see the SD card icon flash red that indicates that data is being transferred to the SD card. Do not attempt to remove the SD card during this phase or it may corrupt the data and the SD card. Wait for the SD card icon to stop flashing before removing the SD card.

SETTINGS

FORMAT SD CARD —

This option is to format your micro SD card which is used for Video recording and for for taking photos when in Photo Mode. We recommend using a 4 to 64Gb micro SD card that is a class 10 and an SDHC type. Please perform this procedure before Zeroing or Recording Videos for the first time.

SLEEP MODE —

Sleep mode enables your system to go into Standby mode to conserve power. When activated your scope will automatically go to sleep mode when it doesn't sense movement for a preset time you select.

You can set Sleep Mode from 5 to 30 min. Once the scope senses movement it will exit Sleep Mode.

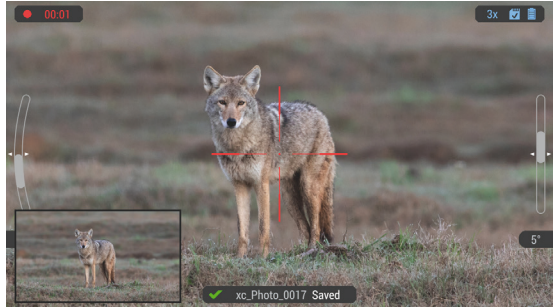

R.F UNITS - This option allows you to choose between meters and yards for SRF measurements.

N. M. SENSITIVITY

- Auto Mode allows the sensor to dynamically adjust to ambient light conditions.
- Low Mode tells the sensor there is too much ambient light.
- High Mode tells the sensor there is very little ambient light.

DISPLAY WIDGETS — Display Widgets allow you to turn On or Off the Roll and Pitch scales.

ZEROING UNITS - This option allows you to choose between MOA and mRad for zeroing your scope.

DATE AND TIME — Date and Time allows you to set your Date and Time of your scope and select 12H or 24H time format.

LANGUAGE — This setting allows the selection of the Language that is used for the menus of the scope: English, German, Danish, Czech, Bulgarian, Ukrainian, Swedish, Slovenian, Slovak, Romanian, Portuguese, Polish, Dutch, Italian, Hungarian, Croatian, French, Finnish, Spanish.

RESTORE FACTORY SETTINGS — This option resets the scope to factory settings, all changes will be restored to initial settings and Zero will be lost. Please write down your Zero X/Y coordinates before performing this function.

WARNINGS AND CAUTIONS

- Always remember to turn off the device when it is not in use.
- Do not disassemble, drop, open, crush, bend, deform, puncture, shred, microwave, incinerate, paint or insert foreign objects: it will void your warranty.
- Keep the scope in the provided protective cover when not in use.
- Avoid contact with dust, steam, and gas.
- This product contains natural rubber latex which may cause allergic reactions.
- The scope is a precision electro-optical instrument and must be handled carefully.
- Do not scratch the external lens surfaces or touch them with your fingers.

CAUTION

Failure to follow these safety instructions could result in damage to the device!

3 YEAR PRODUCT WARRANTY

This product is guaranteed to be free from manufacturing defects in material and workmanship under normal use for a period of 3 (three) years from the date of purchase. In the event a defect that is covered by the foregoing warranty occurs during the applicable period stated above, ATN, at its option, will either repair or replace the product, and such action on the part of ATN shall be the full extent of ATN's liability, and the Customer's sole and exclusive remedy. This warranty does not cover a product (a) used in other than its normal and customary manner; (b) subjected to misuse; (c) subjected to alterations, modifications or repairs by the Customer or by any party other than ATN without prior written consent of ATN; (d) special order or "close-out" merchandise or merchandise sold "as-is" by either ATN or the ATN dealer; or (e) merchandise

that has been discontinued by the manufacturer and either parts or replacement units are not available due to reasons beyond the control of ATN. ATN shall not be responsible for any defects or damage that in ATN's opinion is a result from the mishandling, abuse, misuse, improper storage or improper operation, including use in conjunction with equipment which is electrically or mechanically incompatible with or of inferior quality to the product, as well as failure to maintain the environmental conditions specified by the manufacturer. This warranty is extended only to the original purchaser. Any breach of this warranty shall be waived unless the customer notifies ATN at the address noted below within the applicable warranty period.

The customer understands and agrees that except for the foregoing warranty, no other warranties written or oral, statutory, expressed or implied, including any implied warranty of merchantability or fitness for a particular purpose, shall apply to the product. All such implied warranties are hereby and expressly disclaimed.

LIMITATION OF LIABILITY

ATN will not be liable for any claims, actions, suits, proceedings, costs, expenses, damages or liabilities arising out of the use of this product. Operation and use of the product are the sole responsibility of the Customer. ATN's sole undertaking is limited to providing the products and services outlined herein in accordance with the terms and conditions of this Agreement. The provision of products sold and services performed by ATN to the Customer shall not be interpreted, construed, or regarded, either expressly or implied, as being for the benefit of or creating any obligation toward any third party of legal entity outside ATN and the Customer; ATN's obligations under this Agreement extend solely to the Customer. ATN's liability hereunder for damages, regardless of the form or action, shall not exceed the fees or other charges paid to ATN by the customer or customer's dealer. ATN shall not, in any event, be liable for special, indirect, incidental, or consequential damages, including, but not limited to, lost income, lost revenue, or lost profit, whether such damages were foreseeable or not at the time of purchase, and whether or not such damages arise out of a breach of warranty, a breach of agreement, negligence, strict liability or any other theory of liability.

PRODUCT WARRANTY REGISTRATION

In order to validate the warranty on your product, ATN must receive a completed Product Warranty Registration Card for each unit or complete warranty registration on our website at www.atncorp.com. Please complete the included form and immediately mail it to our Service Center: ATN Corporation, 2400 NW 95 Ave, Doral, FL 33172.

OBTAINING WARRANTY SERVICE

To obtain warranty service on your unit, End-user must notify ATN service department by calling **800-910-2862** or **650-989-5100** or via e-mail **service@atncorp.com** to receive a Return Merchandise Authorization number (RMA).

When returning please take or send the product, postage paid, with a copy of your sales receipt to our service center, ATN Corporation at the address noted above. All merchandise must be fully insured with the correct postage; ATN will not be responsible for improper postage or, missing or damaged merchandise during shipment.

When sending product back, please clearly mark the RMA# on the outside of the shipping box. Please include a letter that indicates your RMA#, Name,

Return Address, reason for service return, Contact information such as valid telephone numbers and/or e-mail address and proof of purchases that will help us to establish the valid start date of the warranty. Product merchandise returns that do not have an RMA listed may be refused or a significant delay in processing may occur.

Estimated Warranty service time is 10-20 business days. End-user/customer is responsible for postage to ATN for warranty service. ATN will cover return postage/shipping to continental USA end-users/customers after warranty repair only if product is covered by aforementioned warranty. ATN will return product after warranty service by domestic UPS ground and/or domestic mail. Any other requested, required or international shipping method the postage/shipping fee will be the responsibility of the end-user/customer.



For customer service and technical support, please contact

American Technologies Network Corp.

2400 NW 95 Ave, Doral, FL 33172

phone: 800-910-2862, 650-989-5100

e-mail: service@atncorp.com

www.atncorp.com